

ÖSSZESZERELÉSI ÚTMUTATÓ

[Dokumentum alcíme]

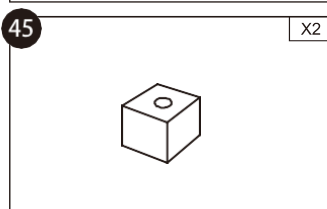
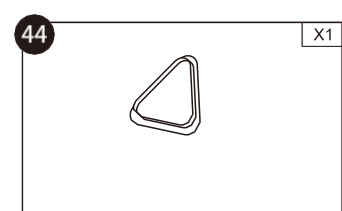
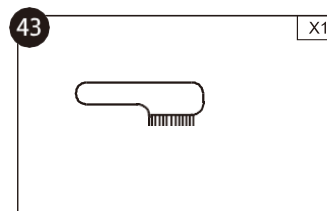
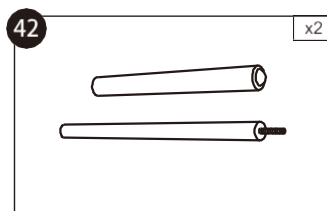
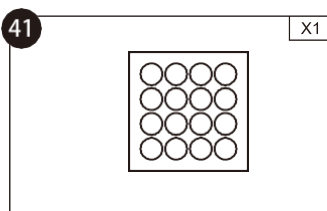
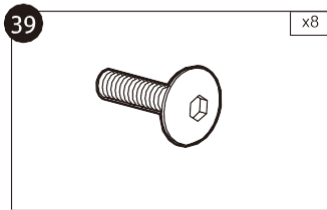
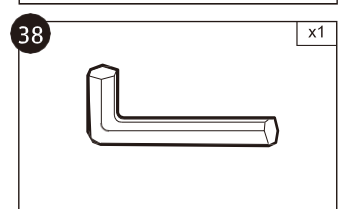
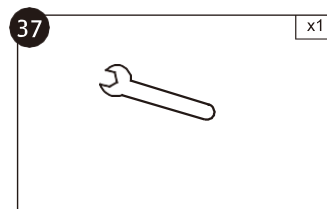
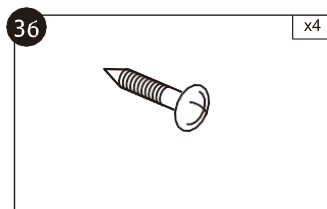
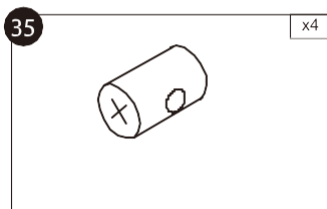
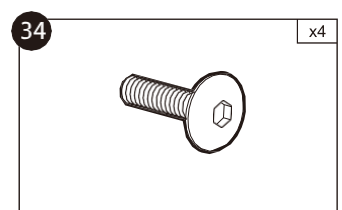
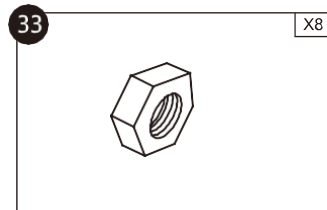
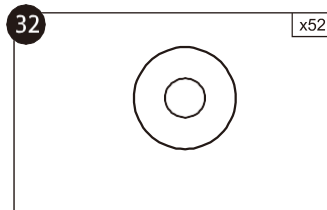
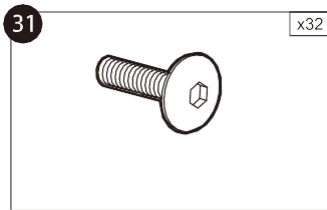
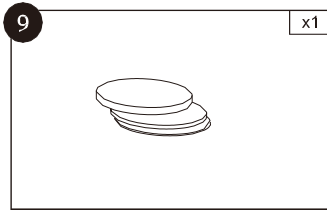
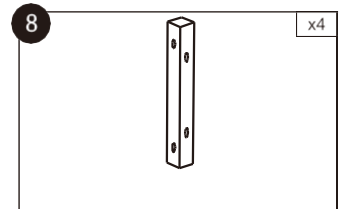
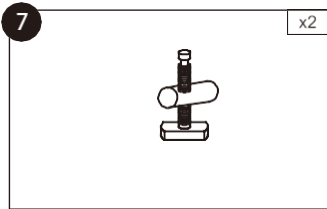
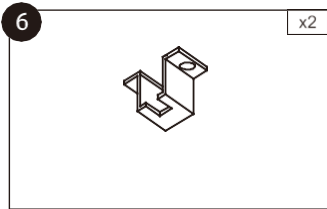
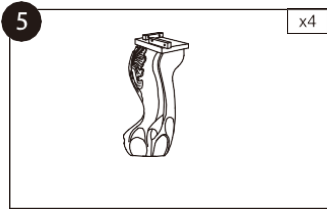
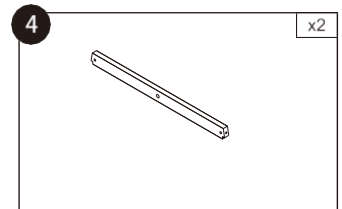
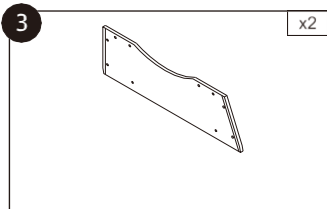
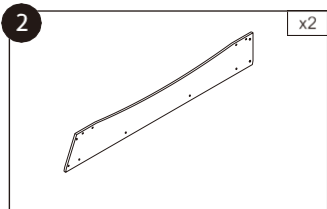
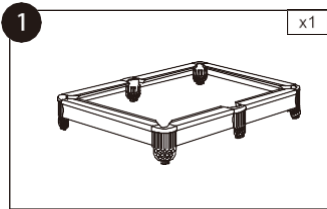
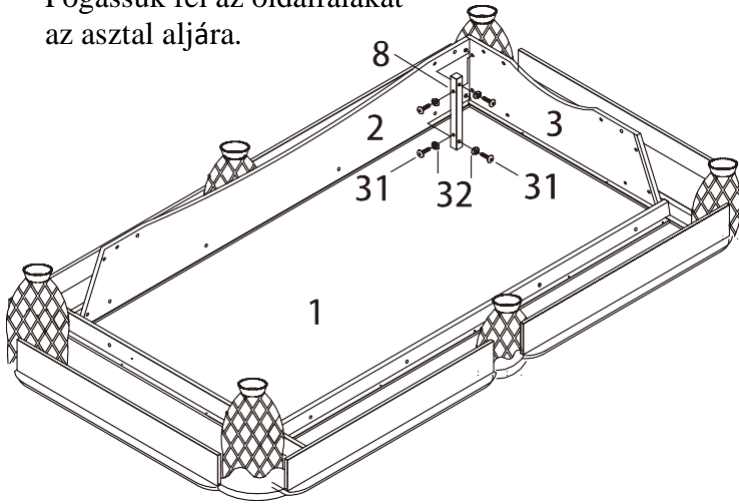

Lépés 1

Fogassuk fel az oldalfalakat az asztal aljára.



Lépés 4

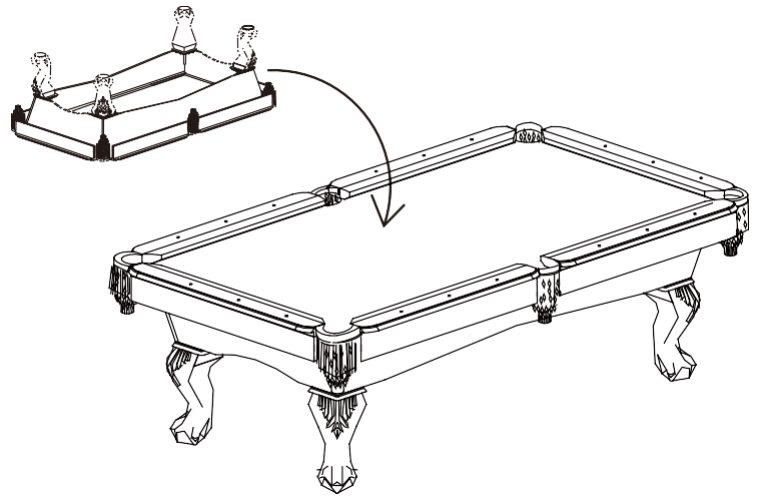

Állítsuk lábaira az asztalt.

Lépés 2

Ügyeljünk, hogy a számozott alkatrészek megfelelő helyre kerüljenek.

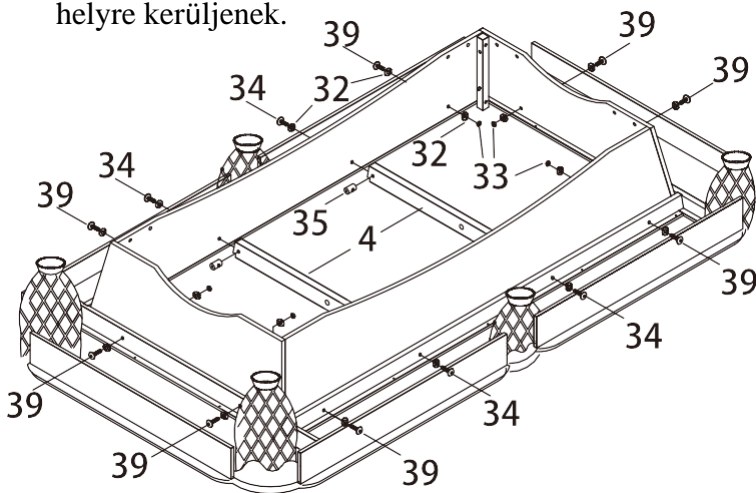

Lépés 5

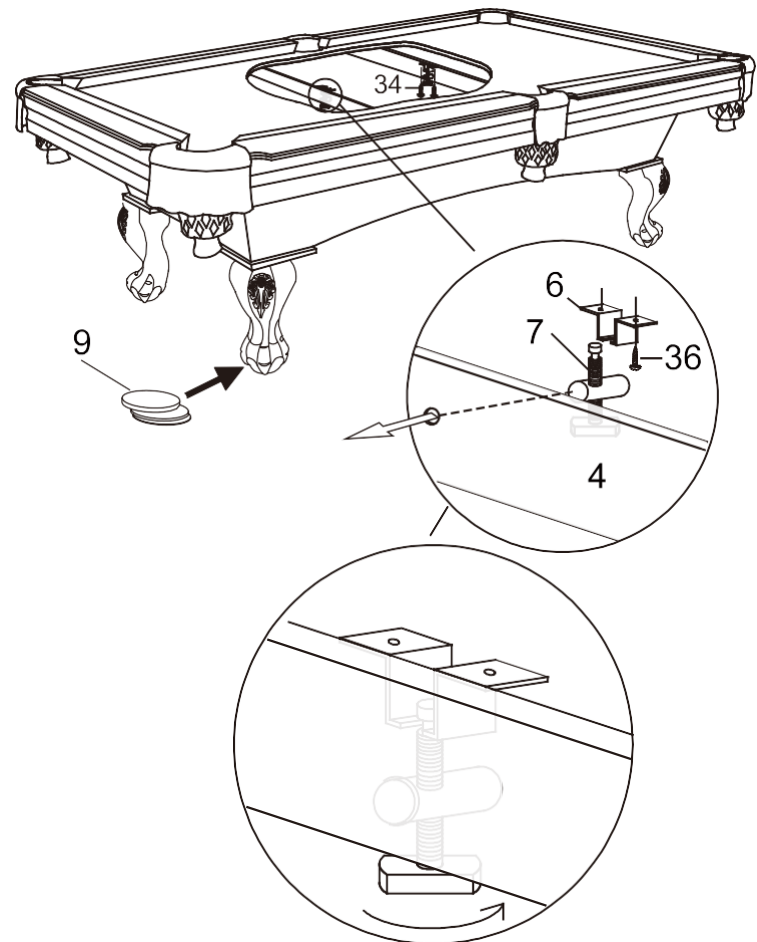

Lépés 3

Fogassuk fel a lábakat.

